



Series D601

Doppler Ultrasonic Flow Meter

Operations & Maintenance
Manual

REV 4/00

PART 1 - TABLE OF CONTENTS

<i>Description</i>	<i>Pages</i>
Quick Start Installation	1.2-1.3
Operating Theory	1.4
Product Limitations	1.5
Model Number Matrix	1.6
Specifications	1.7
<hr/>	
Transducer Installation	2.1-2.5
<hr/>	
Pre-Installation Functional Test	3.1-3.2
Transmitter Installation	3.3-3.4
Power Source Jumper Settings	3.5
Electrical Connections	3.5-3.6
<hr/>	
Power Up and Configuration	3.7
Keypad Operations	3.8-3.19
Trouble Shooting	3.20-3.21
<hr/>	
Appendix	
Fluid Sound Speed Conversions	
Ductile Iron Pipe Data	
Cast Iron Pipe Data	
Steel, SS, PVC Pipe Data	
FPS to GPM Conversion Chart	
Intrinsic Safety Installation	
Statement of Warranty	
Service Information	

PART 1 - QUICK START

General

This manual contains detailed operating instructions for all aspects of the D601 instrument. The following condensed instructions are provided to assist the operator in getting the instrument started up and running as quickly as possible. This pertains to basic operation only. If specific instrument features are to be used or if the installer is unfamiliar with this type of instrument, refer to the appropriate section in the manual for complete details.

1. TRANSDUCER LOCATION

- A. In general, select a mounting location on the piping system with a minimum of 10 pipe diameters (10 X the pipe inside diameter) of straight pipe upstream and 5 straight diameters downstream. See Table 2.1 for additional configurations.
- B. On horizontal pipe, select a position that is between 2 and 4 o'clock on the pipe, with 12 o'clock representing the top. Installations on vertical pipe should be made in an area where the flow moves from bottom to top—ensuring a full pipe of liquid.

2. PIPE PREPARATION AND TRANSDUCER MOUNTING

- A. The piping surface, where the transducers are to be mounted, needs to be clean and dry. Remove loose scale, rust and paint to ensure satisfactory acoustical bonds.
- B. Loosely wrap the appropriate length of strap around the pipe at the location determined in Step 1. Refer to Figure 1.1 for proper orientation of the transducer. For greatest accuracy, point the cable of the transducer in the primary flow direction.
- C. Apply a liberal amount of couplant onto the transducer face. Place the transducer onto the pipe ensuring square and true placement. If an RTV type of couplant (requiring curing time) was utilized, allow sufficient time for curing before applying power to the instrument or moving the cable.

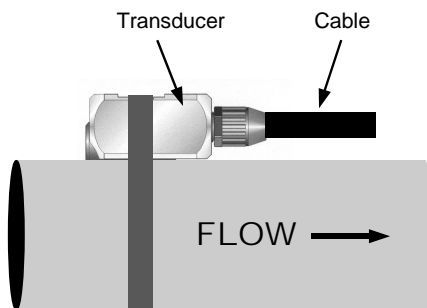

Figure 1.1
Top View of Pipe

PART 1 - QUICK START

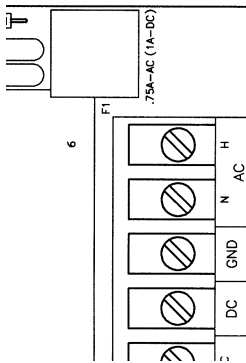
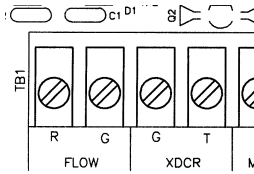

Figure 1.2
Transducer (top picture)
and Power (bottom picture)
Connections

3. TRANSDUCER/POWER CONNECTIONS

- A. Do not attempt to add additional cable to the transducers.
- B. Refer to the DIAGRAMS in Figure 1.2 for proper power and transducer connections. Verify proper jumper selections are in place for the power source. See Figure 3.4.

4. INITIAL SETTINGS AND POWER UP

IMPORTANT!

In order to successfully complete the configuration of the D601 flow meter, the transducer must be mounted on a pipe which is full of a flowing liquid. It is normal to have a zero reading and no signal strength indication with empty pipes or zero flow rate.

- A. Adjust the GAIN control [R13] to 1/4 turn from full counter-clockwise rotation.
- B. Apply power to the instrument.
- C. If the pipe is full of a flowing liquid, the flow meter signal strength will increase from a zero reading. (press the **2nd FUNCT** key, then press **SIGNAL STR**). If the Signal Strength does not increase to a minimum of 000125 counts, gradually turn the GAIN control [R13] clockwise until the indication is between 000125 and 000200. (Do not over adjust this setting as ambient noise can influence readings.)
- D. If possible, turn off the flow in the pipe. Verify that SIGNAL STR. is lower than 000100. If SIGNAL STR. is greater than 000100, verify that the sensor/transmitter are not located near electrically noisy components. (VFDs, inverters, motors, power relays, etc) Verify that DT6 transducer connections are proper and secure. If the SIGNAL STR. remains greater than 000100, consult the Dynasonics Factory for assistance. It is possible that the GAIN control [R13] is set too far clockwise and ambient noise is influencing the readings. Turn the control counter-clockwise until the signal strength decreases to below 000070 counts.
- E. If the instrument passes steps 4C and 4D, the basic setup of the instrument is complete.

PART 1 - GENERAL

General

The Dynasonics D601 flowmeter is designed to measure the flow of liquids and slurries in full-pipe closed systems. The transmitter is field configured to measure flow on a variety of pipes and liquids. The standard product is typically used on pipe sizes ranging from 1 - 120 inch [25 - 1524 mm] pipe I.D. (With the small pipe transducer option, the pipe size range is 0.25 - 1 inch [6 - 25 mm]). A variety of liquid applications can be accommodated: sewage, sludges, concrete, mining slurries, dredging, etc. Because the transducers are non-contacting and have no moving parts, the flow meter is not affected by system pressure, fouling or wear. Standard transducers are rated to 250°F [121°C]. Optional high temperature transducers are rated to operate to 400°F [204°C].

Operating Theory

The basic principle of operation is the measurement of the frequency shift "Doppler" of a reflected ultrasonic signal from discontinuity in the flowing liquid. In theory, these discontinuities can be virtually any amount of suspended bubbles, solids, or interfaces caused by turbulent flow. In practice the degree to which this can be reliably accomplished is a function of the sensitivity and frequency of the transducer and associated transmitter. The D601 design requires greater than 100 PPM of suspended solids or bubbles over 100 microns in size. Should your application be cleaner than this, please check with the factory for information on transit time ultrasonic flowmeters. The transducer which generates and receives the ultrasonic signal supplies the data to the transmitter. The transmitter processes the signal and provides an analog and pulse output for velocity indicating and volumetric totalizing. In addition, the transmitter contains a signal strength indicator which determines satisfactory operation.

PART 1 - GENERAL

Measuring Limits

The flowmeter is typically used as a unidirectional meter and is most accurate when the transducer is mounted in the orientation detailed in this manual. But, the meter will measure flow in both directions — although flow direction will not be indicated or totalized properly. The flowmeter will operate from signals returned from turbulence alone (such as installation directly at pump discharges or downstream from elbows and valves); however, it should be noted that turbulence may vary with flow rates and result in non-linear results. The repeatability of the device is not dependent on most process liquids.

The flowmeter is designed to measure the flow of liquids and slurries, as long as a small, homogeneous quantity of entrained air or suspended solids are present. Without the presence of continuing supply of air or solids, the transmitted pulses are not reflected back to the transducer and the indicator will indicate zero flow.

The signal strength value will indicate a value greater than 100 counts when a minimum size and concentration of suspended particles are available for a reliable flow reading (100 micron and 100 PPM minimum) and the liquid is moving at least 0.1 FPS [0.03 MPS]. Most water-based liquids can be measured from a factory calibrated flowmeter. However, liquids with a heavy solids level (i.e. over 2% by volume), liquids with sound speeds that vary from water (see Appendix - Liquid Sound Speed list) or pipes with liners may have to be field calibrated. This is done by adjusting the Calibration value on the keypad to make the indicator agree with a known flow velocity or a mathematically corrected fluid velocity. All standard flow meters are calibrated to measure the flow of a water-based liquid at 25 degrees C. If the scale range or units need to be changed, the process to do so is covered in detail later in this manual.

PART 1 - GENERAL

The D601 employs modular construction and provides electrical safety for the operator. The display face contains voltages no greater than 9 Vdc and any exposed metal work is electrically connected to Earth Ground. The display face swings open to allow access to user connections.

Serial Number

The serial number and complete model number of your D601 is located on the inside of the transmitter front cover. Should technical assistance be required, please provide the Dynasoncs' Customer Service Department with this information. Email: dynasoncs_technical@racinefed.com.

A part number breakdown of the transducer and transmitter portions of the flowmeter are described below.

Transmitter

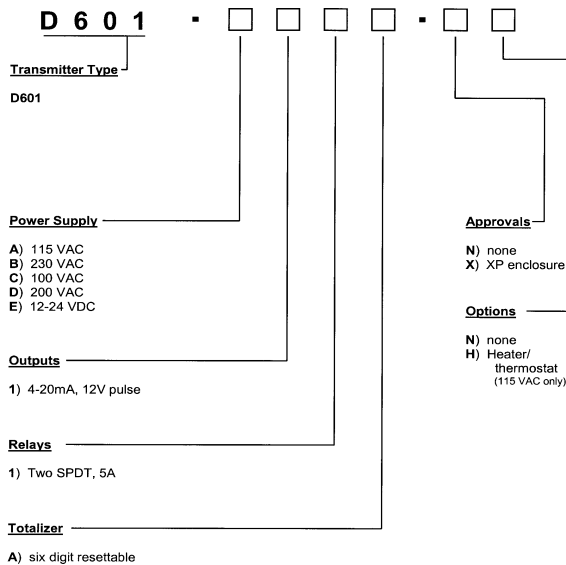

Transducer

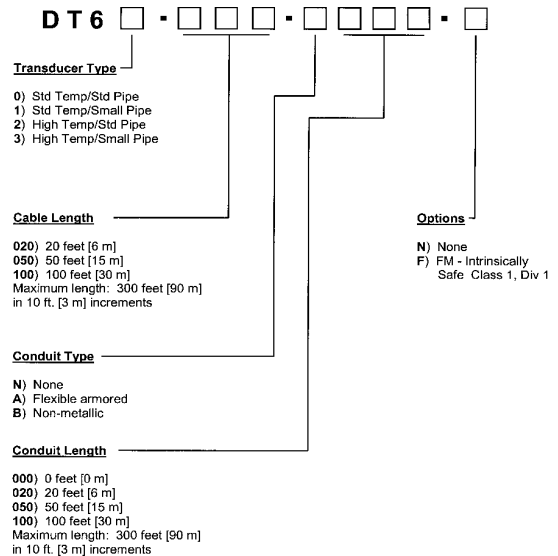

PART 1 - GENERAL

TRANSMITTER

DESCRIPTION	SPECIFICATION
POWER REQUIREMENTS	(Std) 115/230 VAC 50/60 Hz \pm 10% and 12VDC. (Opt) 100/200 VAC 50/60 Hz \pm 10%. Power consumption less than 12 VA.
VELOCITY	0.1-30 FPS [0.03 - 9.1 MPS]
OUTPUTS	4-20 mA, 1000 Ohms max, isolated. 12 VDC pulse, 100 μ S duration, 10 Hz max, pulses with totalizer increments. Two Relays, 5A @ 250 VAC resistive, SPDT
DISPLAY	2 line x 20 character alphanumeric LCD (backlit). Digit height 0.2 inches [5 mm]; 6 digit rate, 8 digit totalizer (resettable)
UNITS:	User configured
RATE U.S. [METRIC]	FPS, GPM, GPH, CFM, MGD, BPM, BPH, BPD [MPS, LPM, M ³ /hr, LPD]
TOTALIZER U.S. [METRIC]	Gallons, barrels (crude oil) [liters, M ³]
AMBIENT CONDITIONS	-22 to 160°F [-30 to 70 °C], 0-95% relative humidity, non-condensing.
ENCLOSURE	NEMA 4X, [IP-65] Fiberglass with SS hardware. 11H x 9.25W x 5.5D inches [280H x 235W x 140D mm]
NON-LINEARITY (ACCURACY)	\pm 2% Full Scale
SENSITIVITY	0.05% of Full Scale
REPEATABILITY	\pm 0.2% of Full Scale
RESPONSE TIME	5-50 seconds, user configured, to 90% of value, step change in flow.
SECURITY	Keypad lockout, access code enable

TRANSDUCER

DESCRIPTION	SPECIFICATION
LIQUID REQUIREMENTS	100 ppm of 100 micron size suspended solids or aeration minimum
TRANSDUCER TO TRANSMITTER DISTANCE	(Std) 20 feet [6.08 meters], flexible armored conduit. (Opt) lengths to 300 feet [90 meters]
PIPE SIZES	(Std) 1 - 120 inches [25 - 3050 mm] pipe I.D. (Opt) 0.25 - 1 inch [6-25 mm] pipe I.D.
TEMPERATURE	(Std) -40° to 180°F [-40° to 82°C] (Opt) -40° to 300°F [-40° to 149°C]
HOUSING MATERIAL	(Std) Aluminum and SS w/epoxy encapsulation
APPROVALS	(Opt) FM approval I.S., Class I, Div 1, Groups A-G. Cable lengths to 100 feet [30 meters]

**Factory
Mutual
System**



PART 2 - TRANSDUCER INSTALLATION

Transducer Mounting Locations

The following list outlines how to install the DT6 transducer for optimal performance, highest reliability and greatest accuracy:

1. Select a transducer site at least 10 pipe diameters downstream from bends, or fittings and 5 pipe diameters upstream. A symmetrical flow pattern is necessary for accuracy and repeatability over the

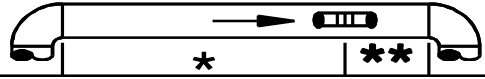
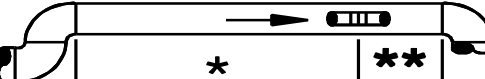
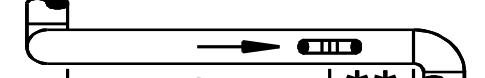
Table 2.1¹

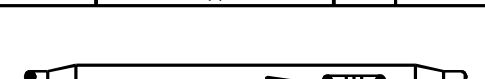
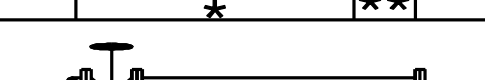
Piping Configuration and Transducer Position	Upstream Dimension:	Downstream Dimension:
	Pipe Diameters	Pipe Diameters
	*	**
	9	3
	14	3
	24	4
	8	3
	8	3
	24	4

¹ The D601 system will provide repeatable measurements on piping systems that do not meet these requirements, but the accuracy of these readings may be influenced to various degrees.

PART 2 - TRANSDUCER INSTALLATION

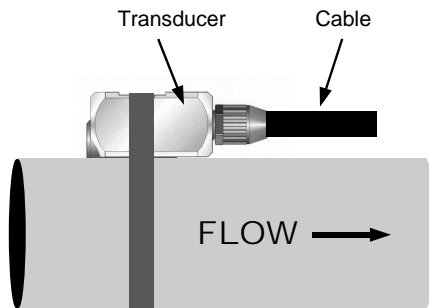

Figure 2.2
Top View of Pipe

operating range of the meter. Down stream from pump or orifices, etc., locate at least 20 diameters.

See **Table 2.1**

2. On horizontal pipe, select a position that is between 2 and 4 o'clock on the pipe, with 12 o'clock representing the top. If the transducer is to be mounted on a vertical pipe, select a section of pipe where the flow is moving from bottom to top (flow moving vertically down a pipe tends to cavitate and provide unreliable operation.)
3. Mount the transducer in the orientation shown in Figure 2.2. The flow meter will read flow in both directions, but will be most accurate if the cable is mounted in the orientation shown—pointing in the primary flow direction.
4. If totalization of the measured fluid is required, the pipe must remain full. The meter will read when the liquid level is greater than the placement of the transducer, but the volumetric measurement will be based on a full pipe, so totalization will be higher than actual.
5. The flowmeter will achieve proper Doppler signals off of turbulence; however, it should be noted that turbulence may not be linear with pump speed changes, nor is the reading necessarily accurate due to the non-uniformity of turbulence.
6. When a liquid has less than 100 PPM of 100 micron or larger particles, try mounting the transducer within 12 inches of a pump discharge or other source of flow turbulence or cavitation. A reading obtained under these circumstances will be repeatable, but not necessarily accurate or linear.
7. It is a good practice to test the flow meter on the piping system before permanently mounting the transducer using RTV. Function can be verified by applying a water soluble lubricant, such as KY-Jelly, and holding the transducer by hand on the pipe in the location where the transducer will be

PART 2 - TRANSDUCER INSTALLATION

Acoustic Couplant Types

permanently mounted. Under flowing liquid conditions, adequate signal is indicated when the Signal Strength indicates between 000125 and 000200 counts.

For proper operation, there cannot be air voids between the traducer face and pipe. The space must be filled with a material which is a good transmitter of sound energy such as:

SILICONE GREASE: Dow Corning 111 R or comparable (-100 to +450 F.) The material must be suitable not to flow at temperature of pipe. Used for temporary survey installations and portable flow meters.

SILICONE RUBBER: Dow Corning 732-RTV R. Excellent for permanent bonding. This adhesive is a recommended bonding agent and easily removable.

INSTALLATION AND PIPE PREPARATION

The cable from the DT6 transducer is provided with either dual-coaxial cables, flexible nylon conduit or PVC coated steel conduit with a 1/2" NPT fitting. The coaxial cable was ordered from the factory at a specific length **UNDER NO CIRCUMSTANCES should the coaxial cable be lengthened as this may de-tune the circuitry and influence performance.**

Small Pipe Transducers

Installation of the DT61 and DT63 small-pipe transducers follow the same procedures as the DT60 and DT62 standard pipe type. The only difference is that the small pipe transducers utilize an integral pipe clamping mechanism with two opposing sensing heads and the standard pipe units use a stainless steel strap.

PART 2 - TRANSDUCER INSTALLATION

Intrinsic Safety Installations

Installations requiring intrinsic safety should refer to the Appendix drawings covering these applications.

1. Pipe Preparation:

For permanent silicone adhesive mounting, after determining the transducer location, some attention must be given to the pipe condition. Before the transducer head is bonded to the pipe surface, an area slightly larger than the flat surface to the transducer head (black rectangle) must be cleaned to bare metal. This means the removal of all paint rust, and scale. Some minor pipe pitting will not cause problems, as the acoustic couplant will take up the voids. In the case where plastic pipe is used, remove all paint and grease so that a smooth, dry surface is exposed.

2. Transducer Mounting:

The transducer center line is designed to mount parallel to the pipe center line. The groove in the transducer body will allow the 1/2" stainless steel strap that was enclosed with the meter to align the transducer properly on the pipe. **DO NOT** mount the transducer on bends, elbows or fittings. Every effort should be made to mount the transducer parallel to the axis of the pipe as well as flat on the pipe. The transducer cable should run in the "down-stream" direction of liquid flow. See **Figure 2.2**.

In horizontal pipe runs, mount the transducer between 2 and 4 o'clock from the top—12 o'clock position; prepare the pipe surface as described. Finish the surface with some emery paper and then wipe the surface with trichlorethylene to thoroughly degrease the contact surface in a area slightly larger than the flat surface of the transducer.

For permanent mounting, use a good silicone based

PART 2 - TRANSDUCER INSTALLATION

adhesive (Dow-732). Spread a bead of the adhesive on the flat surface of the transducer face, covering well. Now spread a bead to the prepared pipe surface and press the head lightly to the pipe. Let the adhesive flow enough to fill in all the area beneath the head. At the same time, clamp (clamp supplied) into place until the silicone has set up. Taping along the edges of the head will hold the adhesive in place. A pad of adhesive must be formed between the transducer face and the pipe. Ensure that no relative movement between the transducer and the pipe takes place during the setup time (about 24 hours). Clamp transducer only tight enough to hold it in place while the adhesive is curing. Tighten for mechanical strength only after 24 hours. Secure the conduit as well.

3. Temporary Mounting and Spot Checks:

For temporary mounting, clean pipe as described and use silicone grease as the acoustical coupling material, holding by hand for spot readings or with a strap clamp for indefinite periods.

PART 3 - PRE-INSTALLATION CHECKOUT

Unpacking

After unpacking, it is recommended to save the shipping carton and packing materials in case the instrument is stored or re-shipped. Inspect the equipment and carton for damage. If there is evidence of shipping damage, notify the carrier immediately.

Functional Test

The D601 flow meter can be checked for basic functionality using the following **Bench Test** procedure. It is recommended that this operation be performed before permanently installing the system.

Procedure:

1. Open the D601 transmitter cover.
2. Connect the transducer cable connector to the terminal locations on the lower left corner of the D601 main circuit card. See **Figure 3.1**.
3. Connect supply power to the appropriate terminal locations on the upper right corner of the main circuit card. See **Figure 3.2**. Verify that the power supply selection jumpers are configured properly—See **Figure 3.4**.
4. Apply power.
5. Verify that the display indicates 0.00 FPS (or 0.0 flow rate of any other unit). If the display does not register 0.0, then press the **2nd FUNCT** key, then press **SIGNAL STR**. Verify that SIGNAL STR. is lower than 000100. If SIGNAL STR. is greater than 000100, verify that the sensor/transmitter are not located near electrically noisy components. (VFDs, inverters, motors, power relays, etc) Verify that DT6 transducer connections are proper and secure. If the SIGNAL STR. remains greater than 000100, consult the Dynasonics Factory for assistance.
6. Press the **2nd FUNCT** key to enter SERVICE MODE. Press the SIGNAL STR key to display SIGNAL STR. XXXXXX.
7. Rub the face of the transducer lengthwise back and

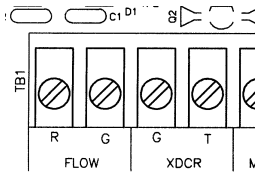

Figure 3.1

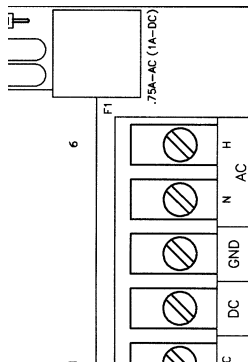

Figure 3.2

PART 3 - PRE-INSTALLATION CHECKOUT

forth with your thumb using moderate pressure. The cycle time should be 1-2 times per second.

8. Verify that signal strength increases with frequency of the rubbing. Typical increases will range from 20-30 counts.
9. Verify that signal strength decreases when rubbing ceases.

Bench Test is Complete

PART 3 - TRANSMITTER INSTALLATION

Transmitter Installation

1. Place the D601 transmitter in a location that is:
 - ◆ Where little vibration exist.
 - ◆ Protected from falling corrosive fluids.
 - ◆ Within ambient temperature limits - 22 to 122°F [-30 to 50°C]
 - ◆ Out of direct sunlight. Direct sunlight may increase temperatures within the transmitter to above maximum limit.
2. Mounting: Refer to **Figure 3.3** for enclosure and mounting dimension details. Ensure that enough room is available to allow for door swing, maintenance and conduit entrances. Secure the enclosure to a flat surface with four appropriate fasteners.
3. Conduit holes. Conduit hubs should be used where cables enter the enclosure. Holes not used for cable entry should be sealed with plugs.

NOTE: Use NEMA 4 [IP65] rated fittings and plugs to maintain the water tight integrity of the enclosure. Generally, the right conduit hole (viewed from front) is used for line power; the left conduit hole for transducer connections.

4. If additional holes are required, (analog outputs, etc.) drill the appropriate size hole in the enclosure's bottom. Use extreme care not to run the drill bit into the wiring or circuits cards.

To access terminal strips for electronic connectors, loosen the two screws in the enclosure door and open the door.

PART 3 - TRANSMITTER INSTALLATION

Dimensional Specifications

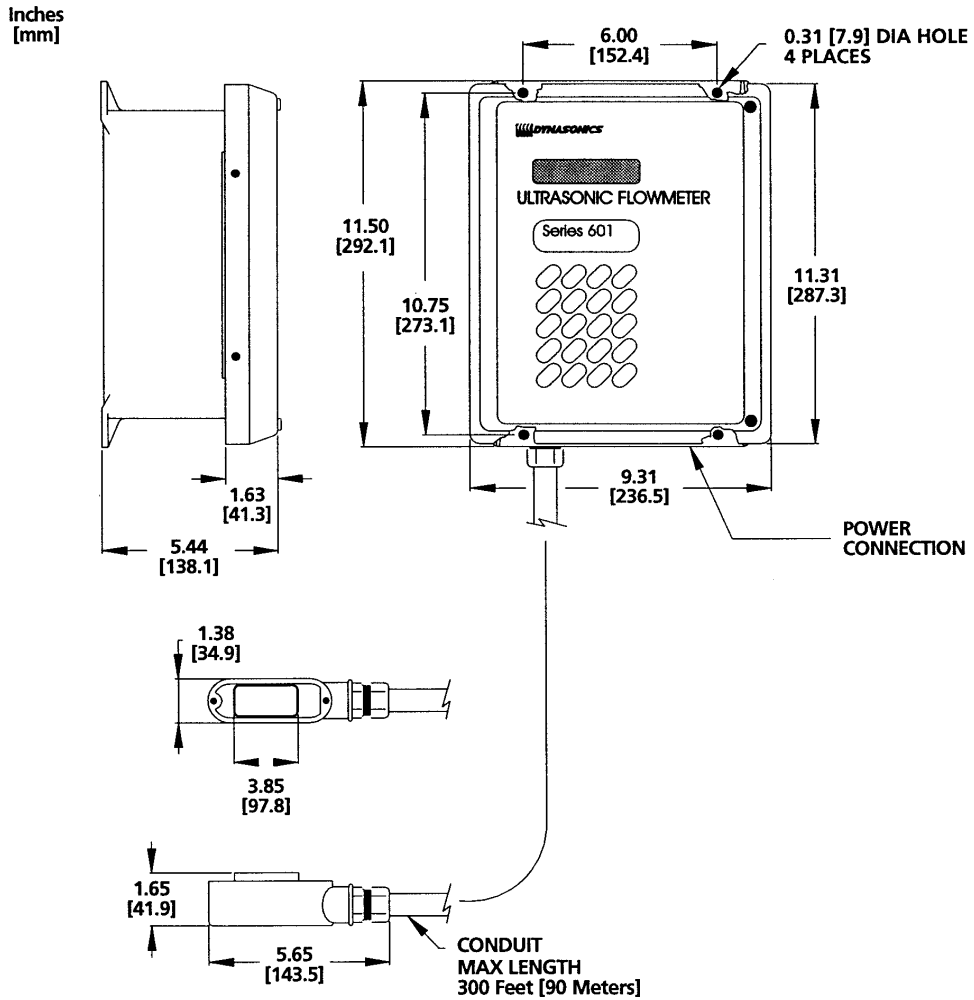

FIGURE 3.3

Important !

NOTE: The transducer cable carries low level signals. Do not attempt to add additional cable to the factory supplied transducer cable.

PART 3 - TRANSMITTER INSTALLATION

4-20mA OUTPUT

The 4-20mA output is proportional to the flow rate measuring scale and can drive a load of up to 1000 ohms. The output is isolated from earth ground and circuit low. Connect the load to the **4-20 mA** connection terminals located on the inside of the D601 enclosure, matching polarity as indicated.

Power Connections

Line power is connected by supplying power to the appropriate terminals located inside of the D601 enclosure. Use wiring practices that conform to local codes (National Electric Code Hand book in the USA). Use only the standard three wire connection. The ground terminal grounds the instrument, which is mandatory for safe operation.

CAUTION: Any other wiring method may be unsafe or cause improper operation of the instrument.

It is recommended not to run line power with other signal wires within the same wiring tray or conduit. Verify that the power supply jumper connections are oriented correctly for the power source being wired. The electronics can be damaged if improper power is connected or if jumpers are not installed correctly. The DC input is not fuse protected. It is recommended that an external fuse be installed if DC power is selected. The fuse should be a 1A delay action type. See **Figure 3.4**

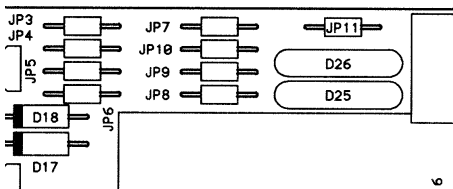

Figure 3.4
Power Supply Jumper Selection

Power Source

115 VAC
230 VAC
100 VAC
12 VDC
24 VDC

Jumpers

JP8, JP10, JP11
JP9, JP11
JP7
JP3, JP5
JP4, JP6

NOTE: This instrument requires clean electrical line power. Do not connect the meter on a circuit which operates lighting ballasts, motors, solenoids, etc.

PART 3 - TRANSMITTER INSTALLATION

Transducer Connections

1. Guide the transducer terminations through the transmitter conduit hole located on the left side of the enclosure. Secure the transducer cable with the supplied conduit nut.
2. The terminals on the transducer cable are coded with wire markings. Connect the appropriate wires to the corresponding screw terminals in the transmitter.

NOTE: The transducer cable carries low level signals. Do not attempt to add additional cable to the factory supplied transducer cable.

If additional cable is required, contact the Dynasonics factory to arrange for an exchange transducer with the appropriate length of cable. Cables to 300 feet [90 meters] are available.

NOTE: An additional hole in the transmitter enclosure is required for outputs. Drill the hole in the the enclosure bottom taking care not to drive the drill bit into wiring or the circuit boards with the transmitter.

CTR Output

The CTR pulse output is proportional to the flow rate measuring scale. This output may be used one of two ways:

- ◆ To drive a 12V logic device or electromechanical totalizers.
- ◆ To drive a low impedance, 12V device. Minimum resistance 50 ohms.

The pulse output pulses with totalizer increments. The connections are located on the right side of the signal processing PCB in the back of the enclosure. The pulse width is fixed at 50 milli-seconds. CTR “ - ” represents circuit low. CTR “ + ” represents 12 Vdc pulse output.

PART 3 - STARTUP AND CONFIGURATION

Before Starting the Instrument

Note: The D601 flow meter system requires a full pipe of flowing liquid before a successful startup can be completed. Do not attempt to make adjustments or change configurations until a full pipe is verified.

Instrument Startup

Procedure:

1. Verify that all wiring is properly connected and routed.
2. Apply power.
3. Adjust the GAIN control [R13] to 1/4 turn from full counter-clockwise rotation.
4. Apply power to the instrument.
5. If the pipe is full of a flowing liquid that contains adequate concentrations of suspended solids, the flow meter signal strength will increase from a zero reading. (press the **2nd FUNCT** key, then press **SIGNAL STR**). If the Signal Strength does not increase to a minimum of 000125 counts, gradually turn the GAIN control [R13] clockwise until the indication is at between 000125 and 000200. (Do not over adjust this setting as ambient noise can influence readings.)
6. If possible, turn off the flow in the pipe. Verify that SIGNAL STR. is lower than 000100. If SIGNAL STR. is greater than 000100, verify that the sensor/transmitter are not located near electrically noisy components. (VFDs, inverters, motors, power relays, etc) Verify that DT6 transducer connections are proper and secure. If the SIGNAL STR. remains greater than 000100, consult the Dynasonics Factory for assistance. It is possible that the GAIN control [R13] is set too far clockwise and ambient noise is influencing the readings. Turn the control counter-clockwise until the signal strength decreases to below 000070 counts.
5. If the instrument passes steps 5 and 6, the basic setup of the instrument is complete.

Important!

It is normal to have low/zero SIGNAL STRENGTH indication at ZERO flow.

PART 3 - KEYPAD CONFIGURATION

After a successful flow meter installation and startup (covered in the previous sections of this manual) the D601 can be keypad configured to provide select engineering unit readings of flow and a scaled 4-20mA output. Configuration inputs are made via the keypad and are stored by the microprocessor. The entries are retained by the flow meter's E²PROM memory in the event of power failure. If fluid velocity readings, FPS or MPS, are the only required measurement keypad configuration is not required.



UP/DOWN Arrows

Allow changing of the D601 configuration constants. Use the UP arrow to increase constant values and the DOWN arrow to decrease values. The arrows can be momentarily pressed to change values incrementally or held to advance continuously. Constants outside of the valid range of the D601 cannot be displayed. The scrolling rate at which the values will change is two tiered. Scrolling will be relatively slow during the first five seconds of a continuous keypad press; the scrolling rate will increase after that time to allow rapid changes of large values.



2nd FUNCT

Controls access to the commands located on the lower half of the keys. After pressing this key the word SERVICE MODE will appear on the LCD indicator.



ENTER

Records and activates the configuration constant value that is displayed on the LCD indicator. Can also be used to return the meter to its run mode.

PART 3 - KEYPAD CONFIGURATION



F1 and F2

Not utilized.

RESET

Caution: Conducts a system reset. All configuration constants will be lost and the D601 will load default values for all constants.

I.D.

Allows entry of a pipes internal diameter. Internal diameters must be entered if volumetric flow rates are to be displayed.

- If a UNITS code for U.S. measurements was made the I.D. value will be entered in inches. Valid ranges for this entry are 0.25 to 120.00 inches.
- If a UNITS code for metric measurement was made the I.D. value will be entered in millimeters. Valid ranges for this entry are 6 to 3050 millimeters.

The appendices in the back of this manual contain tables of common pipe sizes and schedules. If the pipe size does not appear in the table, consult the pipe manufacture or conduct a physical measurement of the pipe internal diameter. Errors in the entry of this value can result in large inaccuracies.

FULL SCALE

Allows entry of the maximum fluid velocity anticipated within the pipe. This value does not have any bearing on displayed flow rates or values, but is used to scale the span value of the 4-20mA analog output. If the analog output is not going to be utilized set this value to 30.00 if measuring in U.S. units or 10.00 if measuring in metric units.

- If a UNITS code for U.S. measurements was made the FULL SCALE value will be entered in FPS (feet per

PART 3 - KEYPAD CONFIGURATION

second). Valid ranges for this entry are 0.00 to 30.00 FPS. Two useful equations that relate liquid velocity to volume:

$$\text{GPM} = 2.45 \times \text{I.D.}^2 \times \text{FPS}$$

$$\text{FPS} = (\text{GPM} \times 0.408) / \text{I.D.}^2$$

I.D. in inches

- If a UNITS code for metric measurement was made the I.D. value will be entered in MPS (meters per second). Valid ranges for this entry are 0 to 10.00 MPS. Two equations that relate liquid velocity to volume are

$$\text{LPM} = 0.047 \times \text{I.D.}^2 \times \text{MPS}$$

$$\text{MPS} = (\text{LPM} \times 21.28) / \text{I.D.}^2$$

I.D. in inches

Note: Attempting to set a FULL SCALE value of less than 0.5 FPS [0.15 MPS] may result in an unstable transmitted output. If flows are typically lower than this range, the LOW FLOW FILTERS and higher DAMPING values may be required.



UNITS

Utilized to set engineering units of measure. There are twelve different selections possible. The **Table 3.1** lists the entry code number, flow rate unit of measure and totalizer unit of measure.

Note: After changing the UNITS value, it may be necessary to change other configuration values accordingly. For example, FULL SCALE, I.D., HIGH/LOW ALARM are influenced by the UNITS entry.

Note: Flow already accumulated will not be correctly compensated for if the UNITS of measure changes.

PART 3 - KEYPAD CONFIGURATION

Table 3.1

UNITS Code	Flow Rate	Totalizer
0	FPS (feet per sec)	N/A
1	GPM (gallons per min)	GALLONS
2	GPH (gallons per hr)	GALLONS
3	MGD (millions of gal pre day)	GALLONS
4	CFM (ft. ³ per min)	CF
5	MPS (meters per sec)	N/A
6	CMH (m ³ per hr)	m ³
7	LPM (liters per min)	Liters
8	MLD (millions of liters per day)	Liters
9	BPM (barrels per min)	BARRELS
10	BPH (barrels per hr)	BARRELS
11	BPD (barrels per day)	BARRELS

PART 3 - KEYPAD CONFIGURATION

HIGH ALARM

HIGH ALARM (Labeled RELAY-1 on the Main PCB)

Controls the set-point of the SPDT relay labeled RELAY-1 on the Main PCB. Enter a liquid velocity at which a relay-contact action is desired. Relay contacts are utilized for signaling flow rate conditions that are higher or lower than a desired set point. If a relay setting is made very close to a nominal liquid velocity, relay “chatter” (rapid opening and closing of the relay) may result.

- If a UNITS code for U.S. measurements was made the HIGH ALARM value will be entered in FPS. Valid ranges for this entry are 0.00 to 30.00 FPS.
- If a UNITS code for metric measurements was made the HIGH ALARM value will be entered in MPS. Valid ranges for this entry are 0.00 to 10.00 MPS.

LOW ALARM

LOW ALARM (Labeled RELAY-2 on the Main PCB)

Controls the set-point of the SPDT relay labeled RELAY-2 on the Main PCB. Enter a liquid velocity at which a relay-contact action is desired. Relay contacts are utilized for signaling flow rate conditions that are higher or lower than a desired set point. If a relay setting is made very close to a nominal liquid velocity, relay “chatter” (rapid opening and closing of the relay) may result.

- If a UNITS code for U.S. measurements was made the HIGH ALARM value will be entered in FPS. Valid ranges for this entry are 0.00 to 30.00 FPS.
- If a UNITS code for metric measurements was made the HIGH ALARM value will be entered in MPS. Valid ranges for this entry are 0.00 to 10.00 MPS.

TOTAL MULT

TOTAL MULT

Utilized for setting the flow totalizer exponent and changing the External Counter output. This feature is useful for accommodating a very large accumulated flow. The exponent is a “ X 10ⁿ” multiplier, where “n” can be from 0 (10⁰, X 1 multiplier) to 4 (10⁴, X 10,000 multiplier).

PART 3 - KEYPAD CONFIGURATION

The External Counter output, available at the two terminals labeled CTR on the Main PCB, is influenced by the TOTAL MULT value. Since the output is designed to operate electromechanical accumulators, large flow rates will require that the TOTAL MULT be set to a value usable by these types of counters (typically speeds no faster than 3 cps). The following chart tabulates suggested settings vs. flow ranges:

Exponent	Multiplier	Useable CTR Range: GPM or LPM
0	X1	30-600
1	X10	300-6,000
2	X100	3,000-60,000
3	X1,000	30,000-600,000
4	X10,000	300,000-6,000,000



TOTAL ON/OFF

This key has three functions:

Key press number	Operation
First press	Stops the internal totalizer/ external CTR and displays the last value
Second press	Resets the internal totalizer to zero

(continued)

PART 3 - KEYPAD CONFIGURATION

(continued)

Third press	Restarts the internal totalizer/external CTR (The internal totalizer starts from zero.)
-------------	--

If inhibiting (pausing) the totalizer is necessary, there are two methods suggested:

1. Connect an external totalizer to the CTR terminals. See the section of this manual related to CTR electrical connections for connection parameters.
2. To inhibit the internal totalizer without resetting the accumulation, press the TEST key to pause the accumulation. Press the ENTER key to resume accumulation.



LOCK ON

To ensure security of the configuration and accumulated flow, the keypad can be locked. To enable the keyboard lock out, press LOCK ON key, the display will show LOCK ON. Press ENTER to return to Run mode. To turn the lock off, press the LOCK ON key. Use the arrow keys to set a value of **125**. Press the ENTER key. The display will show LOCK OFF to acknowledge that all keypad entries can now be made.



CAL

A few factors can influence the readings of a D601 flow meter. The CAL entry allows the user to compensate for flow discrepancies without affecting the factory calibration. Examples of situations that can cause reading discrepancies are:

- Operations on liquids with sonic velocity carrying properties that are different from water. See the table

PART 3 - KEYPAD CONFIGURATION

of correction factors located in the Appendix of this manual for Liquid Sound Speed and their associated correction factors.

- Transducer mounted in non-recommended locations.

By applying a CAL value other than 100%, the factory-calibrated readings will be altered by the percentage entered. This CAL value will be reflected in the display, 4-20mA and CTR outputs and relay settings.

For example, if a reading of 175 GPM is displayed and the known flow rate is 160 GPM, a CAL value of

$$\frac{160 \text{ GPM}}{175 \text{ GPM}} \times 100 = 91.4\%$$

The D601 will not allow decimal values to be entered as a CAL constant, so round to the nearest whole number; in this case 91%.

Acceptable input ranges for the CAL constant are 0-255%.



DAMP

In installations where very turbulent or erratic flow is encountered, increasing the Damping setting can increase display and output stability. The DAMP setting increases and decreases the response time of the flow meter display and outputs. To set the damping time constant, press the DAMP key. Set a value between 1 and 10, 1 having the fastest response and 10 having the slowest response. Press ENTER to complete the configuration.



TEST

The meter contains a test function for verification of the 4-20mA analog and CTR external counter outputs. To activate the test function, press the TEST key. Verify that 20mA is flowing in the 4-20mA output and verify that the CTR output is supplying 50mS pulses. Press ENTER to exit the test function.

PART 3 - KEYPAD CONFIGURATION

**2nd
FUNCT**

**SIGNAL
STR**

2nd FUNCT - SERVICE MODE

{2nd FUNCT} SIGNAL STR

Displays the raw Doppler signal strength value. This value will increase as the velocity of the liquid increases. Typically, a liquid flowing at a velocity greater than 0.2 FPS [0.06 MPS], with adequate suspended solids (100 ppm or 100 micron or larger solids) or aeration, will produce SIGNAL STR readings of at least 000125 counts.

NOTE: If the liquid is not flowing a low SIGNAL STR reading is non-conclusive. If a high SIGNAL STR is indicated at zero flow rate, it indicates that a source of interference (another ultrasonic instrument, VFD, or poor electrical ground) may be present. Verify that SIGNAL STR increases when the flow starts. If it does, increase the SS CUTOFF setting (see SS CUTOFF).

If SIGNAL STR is lower than 100 counts in a flowing liquid, one or more of the following steps may need to be invoked:

1. If the liquid velocity is less than 1 FPS (0.3 MPS) turn SW-1 "LOW FLOW" switch ON. (This dual DIP switch is located near the center of the Main PCB.)
2. If SW-1 did not cause an increase in SIGNAL STR to a level above 100, turn ON SW-2.
3. There may not be adequate reflectors for the Doppler principle to operate. The DT6 transducer can be relocated to a source of liquid degasification, such as would be found a 1-3 diameters down stream of a 90-degree elbow. A surrogate source of aeration can also be introduced by bleeding a small amount of compressed air into the line several diameters upstream of the DT6 transducer.

PART 3 - KEYPAD CONFIGURATION



{2nd FUNCT} 4 mA

The 4-20mA output on standard D601 flow meters is scaled at zero flow equals 4mA and 20 FPS (6.08 MPS) equals 20mA. The 4mA key allows fine adjustments to be made to the “zero” of the 4-20mA output or allows offset to be placed on the 4-20mA output. To adjust the 4mA output, an ammeter or reliable reference connection to the 4-20mA output must be present.

Procedure:

1. Either break the present current loop and connect the ammeter in series (disconnect either wire at the terminal block labeled 4-20mA on the Main PCB of the D601) or, if this output is not being utilized, connect the ammeter + to the + terminal and – to the – terminal of the 4-20mA output.
2. Press the 4mA key.
3. With no flow moving through the pipe, adjust the setting count using the arrow keys until 4.00mA is indicated on the ammeter. The typical count value range for this setting is between 3350 and 3850.
4. Press ENTER to store the value.
5. Re connect the 4-20mA output circuitry as required.



{2nd FUNCT} VEL ADC

Press VEL ADC to display the raw analog to digital converter counts that are being processed by the microprocessor. This count value will vary linearly with flow rate from 0000 at zero flow rate to 1024 at maximum full-scale flow rate. No modifications of this count can be made, this display is for diagnostic purposes only.



{2nd FUNCT} BLANKING

This key is unused.

PART 3 - KEYPAD CONFIGURATION



{2nd FUNCT} 20mA

The 4-20mA output on standard D601 flow meters is scaled at zero flow equals 4mA and 20 FPS (6.08 MPS) equals 20mA. The 20mA key allows fine adjustments to be made to the “span” of the 4-20mA output. To adjust the 20mA output, an ammeter or reliable reference connection to the 4-20mA output must be present.

Procedure:

1. Either break the present current loop and connect the ammeter in series (disconnect either wire at the terminal block labeled 4-20mA on the Main PCB of the D601) or, if this output is not being utilized, connect the ammeter + to the + terminal and – to the – terminal of the 4-20mA output.
2. Press the 20mA key.
3. With maximum flow moving through the pipe, adjust the setting count using the arrow keys until 20.00mA is indicated on the ammeter. The typical count value range for this setting is between 1450 and 1950.
4. Press ENTER to store the value.
5. Re connect the 4-20mA output circuitry as required.



{2nd FUNCT} SS CUTOFF

This entry represents the signal strength cutoff level (low velocity cutoff). At flow rates below 0.2 FPS [0.06 MPS] the readings displayed by the D601 are unreliable. By utilizing the default SS CUTOFF of 100 counts, small unstable readings at low flow rates will be avoided.

Note: If SS CUTOFF is set to a level higher than the SIGNAL STR value the meter will not show flow or output any values.

PART 3 - KEYPAD CONFIGURATION



{2nd FUNCT} **INPUT F.S.**

This key is used to select a maximum velocity that the instrument will operate. Choices are 10, 20 and 30 FPS. It is not recommended to deviate alter this value from factory settings, as certain spans have been set that correlate to the set maximum velocity. Consult the Dynasonics factory for adjustment procedures.



{2nd FUNCT} **DAC 3**

This key is not used.



{2nd FUNCT} **BACK LIGHT**

Toggles the electro-luminescent LCD back lighting ON and OFF. This type of back lighting has an illumination half-life of approximately one year. If the instrument is left unattended for long periods of time, turning the back lighting OFF can preserve the electro-luminescent panel and save a small amount of power.



{2nd FUNCT} **CONTRAST**

This setting allows the adjustment of the LCD contrast. An LCD's viewing quality is affected by temperature, ambient lighting, back lighting and viewing angle. Adjust the contrast level to provide the best contrast possible. Default count is 50.

PART 3 - TROUBLE SHOOTING

CONDITION	POSSIBLE CAUSE
Unit does not turn “ON” when power is applied	<ul style="list-style-type: none">• Verify that AC power source is live.• Test the fuse• Verify that proper power supply jumpers are in place.
FAULT CONDITION is indicated on LCD indicator	<ul style="list-style-type: none">• Fault conditions can arise from several causes: electrical surges, short circuits, open circuits, etc. To clear a “Fault Condition”, press 2nd Function then press Reset. Use the arrow keys to change the Fault code number to “0”. Press Enter. If the meter resumes measuring flow, no permanent damage was incurred.• Ensure that the transducer is properly mounted to the pipe.• Verify that transducer connections are correct• Ensure that the pipe is full of moving liquid.• If SIGNAL STR is less than 000100 counts and flow rate is greater than 1 FPS [0.3 MPS], adjust GAIN control (R13 on the Main PCB) till SIGNAL STR reaches at least 000125 counts.• On cleaner liquids, move the transducers closer to a 90° pipe elbow.• If GND connection and pipe are at different potentials, ground D601 to pipe potential.• If Variable Frequency Drives are being utilized, verify that the D601 obtains a flow indication when the pump turns OFF. If it does, contact the Dynasonics factory.

PART 3 - TROUBLE SHOOTING

Stability of flow readings are unsatisfactory

- Increase the DAMP constant from keypad.
- Move transducers to a location further from piping tees, elbows, valves, filters,

Erroneous Reading

- Transducer mounted incorrectly or not true to the pipe.
- Another local ultrasonic instrument is operating at about the same frequency [consult the Dynasonics factory].
- Presence of large amounts of suspended solids or aeration. Use CAL constant to compensate.
- Sources of radiated interference are present. Apply appropriate shielding.
- An electrically noisy power supply is powering the D601. Power the meter with a circuit that does not power motors,

The D601 display indicates flow, when true fluid velocity is zero.

- Verify that residual leakage and flow is not present. [i.e. leaking check valves]
- Verify that GAIN control (R13 on the Main PCB) is not adjusted too high. With nominal flow running through the pipe, adjust GAIN control till the display zeros with no flow.

APPENDIX

Appendix

Fluid Sound Speed Conversions

Pipe Dimension Chart: Ductile Iron

Pipe Dimension Chart: Cast Iron

Pipe Dimension Chart: Steel, SS, PVC

Velocity to Volumetric Conversion Chart

Intrinsic Safety Connections

Statement of Warranty

Customer Service

Fluid Sound Speeds

Original Date: 10/19/99
 Revision: none
 Revision Date: none
 File: I:/dynasonics/dyna_code/tables/doppler ss conversions.xls
 120.0176921

Fluid	Specific Gravity 20 degrees C	Sound Speed		Doppler
		m/s	ft/s	Calibration Entry relative to 25C water
Acetate, Butyl (n)		1270	4163.9	85
Acetate, Ethyl	0.901	1085	3559.7	72
Acetate, Methyl	0.934	1211	3973.1	81
Acetate, Propyl		1280	4196.7	85
Acetone	0.79	1174	3851.7	78
Alcohol	0.79	1207	3960.0	81
Alcohol, Butyl (n)	0.83	1270	4163.9	85
Alcohol, Ethyl	0.83	1180	3868.9	79
Alcohol, Methyl	0.791	1120	3672.1	75
Alcohol, Propyl (l)		1170	3836.1	78
Alcohol, Propyl (n)	0.78	1222	4009.2	82
Ammonia (35)	0.77	1729	5672.6	115
Aniline (41)	1.02	1639	5377.3	109
Benzene (29,40,41)	0.88	1306	4284.8	87
Benzol, Ethyl	0.867	1338	4389.8	89
Bromine (21)	2.93	889	2916.7	59
n-Butane (2)	0.60	1085	3559.7	72
Butyrate, Ethyl		1170	3836.1	78
Carbon dioxide (26)	1.10	839	2752.6	56
Carbon tetrachloride	1.60	926	3038.1	62
Chloro-benzene	1.11	1273	4176.5	85
Chloroform (47)	1.49	979	3211.9	65
Diethyl ether	0.71	985	3231.6	66
Diethyl Ketone		1310	4295.1	87
Diethylene glycol	1.12	1586	5203.4	106
Ethanol	0.79	1207	3960.0	81
Ethyl alcohol	0.79	1207	3960.0	81
Ether	0.71	985	3231.6	66
Ethyl ether	0.71	985	3231.6	66
Ethylene glycol	1.11	1658	5439.6	111
Freon R12		774.2	2540	52
Gasoline	0.7	1250	4098.4	83
Glycerin	1.26	1904	6246.7	127
Glycol	1.11	1658	5439.6	111
Isobutanol	0.81	1212	3976.4	81
Iso-Butane		1219.8	4002	81
Isopentane (36)	0.62	980	3215.2	65
Isopropanol (46)	0.79	1170	3838.6	78
Isopropyl alcohol (46)	0.79	1170	3838.6	78
Kerosene	0.81	1324	4343.8	88
Linalool		1400	4590.2	93

Linseed Oil	.925-.939	1770	5803.3	118
Methanol (40,41)	0.79	1076	3530.2	72
Methyl alcohol (40,44)	0.79	1076	3530.2	72
Methylene chloride (3)	1.33	1070	3510.5	71
Methylethyl Ketone		1210	3967.2	81
Motor Oil (SAE 20/30)	.88-.935	1487	4875.4	99
Octane (23)	0.70	1172	3845.1	78
Oil, Castor	0.97	1477	4845.8	99
Oil, Diesel	0.80	1250	4101	83
Oil (Lubricating X200)		1530	5019.9	102
Oil (Olive)	0.91	1431	4694.9	96
Oil (Peanut)	0.94	1458	4783.5	97
Paraffin Oil		1420	4655.7	95
Pentane	0.626	1020	3346.5	68
Petroleum	0.876	1290	4229.5	86
1-Propanol (46)	0.78	1222	4009.2	82
Refrigerant 11 (3,4)	1.49	828.3	2717.5	55
Refrigerant 12 (3)	1.52	774.1	2539.7	52
Refrigerant 14 (14)	1.75	875.24	2871.5	58
Refrigerant 21 (3)	1.43	891	2923.2	59
Refrigerant 22 (3)	1.49	893.9	2932.7	60
Refrigerant 113 (3)	1.56	783.7	2571.2	52
Refrigerant 114 (3)	1.46	665.3	2182.7	44
Refrigerant 115 (3)		656.4	2153.5	44
Refrigerant C318 (3)	1.62	574	1883.2	38
Silicone (30 cp)	0.99	990	3248	66
Toluene (16,52)	0.87	1328	4357	89
Transformer Oil		1390	4557.4	93
Trichlorethylene		1050	3442.6	70
1,1,1-Trichloro-ethane	1.33	985	3231.6	66
Turpentine	0.88	1255	4117.5	84
Water, distilled (49,50)	0.996	1498	4914.7	100
Water 0 degrees C		1402	4596.7	94
Water 20 degrees C		1482	4859.0	99
Water 40 degrees C		1529	5013.1	102
Water 60 degrees C		1551	5085.2	103
Water 80 degrees C		1554	5095.1	104
Water 100 degrees C		1543	5059.0	103
Water 120 degrees C		1519	4980.3	101
Water 140 degrees C		1485	4868.9	99
Water 160 degrees C		1440	4721.3	96
Water 180 degrees C		1390	4557.4	93
Water 200 degrees C		1333	4370.5	89
Water, heavy	1	1400	4593	93
Water, sea	1.025	1531	5023	102
Wood Alcohol (40,41)	0.791	1076	3530.2	72
m-Xylene (46)	0.868	1343	4406.2	90
o-Xylene (29,46)	0.897	1331.5	4368.4	89
p-Xylene (46)		1334	4376.8	89



Ductile Iron Pipe

Standard Classes

Pipe Size (inches)	Outside Diameter (inches)	Class 50		Class 51		Class 52		Class 53		Class 54		Class 55		Class 56		Cement Lining Std./Double Thickness
		ID	Wall	ID	Wall	ID	Wall	ID	Wall	ID	Wall	ID	Wall	ID	Wall	
3	3.96			3.46	0.25	3.40	0.28	3.34	0.31	3.28	0.34	3.22	0.37	3.14	0.41	.123/.250
4	4.80			4.28	0.26	4.22	0.29	4.16	0.32	4.10	0.35	4.04	0.38	3.93	0.44	
6	6.90	6.40	0.25	6.34	0.28	6.28	0.31	6.22	0.34	6.16	0.37	6.10	0.40	6.04	0.43	
8	9.05	8.51	0.27	8.45	0.30	8.39	0.33	8.33	0.36	8.27	0.39	8.21	0.42	8.15	0.45	
10	11.10	10.32	0.39	10.46	0.32	10.40	0.35	10.34	0.38	10.28	0.41	10.22	0.44	10.16	0.47	
12	13.20	12.58	0.31	12.52	0.34	12.46	0.37	12.40	0.40	12.34	0.43	12.28	0.46	12.22	0.49	
14	15.30	14.64	0.33	14.58	0.36	14.52	0.39	14.46	0.42	14.40	0.45	14.34	0.48	14.28	0.51	.1875/.375
16	17.40	16.72	0.34	16.66	0.37	16.60	0.40	16.54	0.43	16.48	0.46	16.42	0.49	16.36	0.52	
18	19.50	18.80	0.35	18.74	0.38	18.68	0.41	18.62	0.44	18.56	0.47	18.50	0.50	18.44	0.53	
20	21.60	20.88	0.36	20.82	0.39	20.76	0.42	20.70	0.45	20.64	0.48	20.58	0.51	20.52	0.54	
24	25.80	25.04	0.38	24.98	0.41	24.92	0.44	24.86	0.47	24.80	0.50	24.74	0.53	24.68	0.56	
30	32.00	31.22	0.39	31.14	0.43	31.06	0.47	30.98	0.51	30.90	0.55	30.82	0.59	30.74	0.63	.250/.500
36	38.30	37.44	0.43	37.34	0.48	37.06	0.62	37.14	0.58	37.40	0.45	36.94	0.68	36.84	0.73	
42	44.50	43.56	0.47	43.44	0.53	43.32	0.59	43.20	0.65	43.08	0.71	42.96	0.77	42.84	0.83	
48	50.80	49.78	0.51	49.64	0.58	49.50	0.65	49.36	0.72	49.22	0.79	49.08	0.86	48.94	0.93	
54	57.10	55.96	0.57	55.80	0.65	55.64	0.73	55.48	0.81	55.32	0.89	55.16	0.97	55.00	1.05	



Cast Iron Pipe Standard Classes

Size (Inches)	CLASS A			CLASS B			CLASS C			CLASS D			CLASS E			CLASS F			CLASS G			CLASS H		
	O.D. Inch	I.D. Inch	Wall	O.D. Inch	I.D. Inch	Wall	O.D. Inch	I.D. Inch	Wall	O.D. Inch	I.D. Inch	Wall	O.D. Inch	I.D. Inch	Wall	O.D. Inch	I.D. Inch	Wall	O.D. Inch	I.D. Inch	Wall	O.D. Inch	I.D. Inch	Wall
3	3.80	3.02	0.39	3.96	3.12	0.42	3.96	3.06	0.45	3.96	3.00	0.48												
4	4.80	3.96	0.42	5.00	4.10	0.45	5.00	4.04	0.48	5.00	3.96	0.52												
6	6.90	6.02	0.44	7.10	6.14	0.48	7.10	6.08	0.51	7.10	6.00	0.55	7.22	6.06	0.58	7.22	6.00	0.61	7.38	6.08	0.65	7.38	6.00	0.69
8	9.05	8.13	0.46	9.05	8.03	0.51	9.30	8.18	0.56	9.30	8.10	0.60	9.42	8.10	0.66	9.42	8.10	0.66	9.60	8.10	0.75	9.60	8.00	0.8
10	11.10	10.10	0.50	11.10	9.96	0.57	11.40	10.16	0.62	11.40	10.04	0.68	11.60	10.12	0.74	11.60	10.00	0.80	11.84	10.12	0.86	11.84	10.00	0.92
12	13.20	12.12	0.54	13.20	11.96	0.62	13.50	12.14	0.68	13.50	12.00	0.75	13.78	12.14	0.82	13.78	12.00	0.89	14.08	12.14	0.97	14.08	12.00	1.04
14	15.30	14.16	0.57	15.30	13.98	0.66	15.65	14.17	0.74	15.65	14.01	0.82	15.98	14.18	0.90	15.98	14.00	0.99	16.32	14.18	1.07	16.32	14.00	1.16
16	17.40	16.20	0.60	17.40	16.00	0.70	17.80	16.20	0.80	17.80	16.02	0.89	18.16	16.20	0.98	18.16	16.00	1.08	18.54	16.18	1.18	18.54	16.00	1.27
18	19.50	18.22	0.64	19.50	18.00	0.75	19.92	18.18	0.87	19.92	18.00	0.96	20.34	18.20	1.07	20.34	18.00	1.17	20.78	18.22	1.28	20.78	18.00	1.39
20	21.60	20.26	0.67	21.60	20.00	0.80	22.06	20.22	0.92	22.06	20.00	1.03	22.54	20.24	1.15	22.54	20.00	1.27	23.02	20.24	1.39	23.02	20.00	1.51
24	25.80	24.28	0.76	25.80	24.02	0.89	26.32	24.22	1.05	26.32	24.00	1.16	26.90	24.28	1.31	26.90	24.00	1.45	27.76	24.26	1.75	27.76	24.00	1.88
30	31.74	29.98	0.88	32.00	29.94	1.03	32.40	30.00	1.20	32.74	30.00	1.37	33.10	30.00	1.55	33.46	30.00	1.73						
36	37.96	35.98	0.99	38.30	36.00	1.15	38.70	35.98	1.36	39.16	36.00	1.58	39.60	36.00	1.80	40.04	36.00	2.02						
42	44.20	42.00	1.10	44.50	41.94	1.28	45.10	42.02	1.54	45.58	42.02	1.78												
48	50.50	47.98	1.26	50.80	47.96	1.42	51.40	47.98	1.71	51.98	48.00	1.99												
54	56.66	53.96	1.35	57.10	54.00	1.55	57.80	54.00	1.90	58.40	53.94	2.23												
60	62.80	60.02	1.39	63.40	60.06	1.67	64.20	60.20	2.00	64.82	60.06	2.38												
72	75.34	72.10	1.62	76.00	72.10	1.95	76.88	72.10	2.39															
84	87.54	84.10	1.72	88.54	84.10	2.22																		



Steel, Stainless Steel, P.V.C.

Standard Schedules

Nominal Pipe Size Inches	OUTSIDE DIAMETER	SCH. 5		SCH. 10 (LTWALL)		SCH. 20		SCH. 30		STD.		SCH. 40		SCH. 60		X STG.		SCH. 80		SCH. 100		SCH. 120		SCH. 140		SCH. 180		
		ID	Wall	ID	Wall	ID	Wall	ID	Wall	ID	Wall	ID	Wall	ID	Wall	ID	Wall	ID	Wall	ID	Wall	ID	Wall	ID	Wall	ID	Wall	
1	1.315	1.185	0.065	1.097	0.109					1.049		1.049	0.133			0.957	0.179	0.957	0.179								0.815	0.250
1.25	1.660	1.530	0.065	1.442	0.109					1.380		1.380	0.140			1.278	0.191	1.278	0.191								1.160	0.250
1.5	1.900	1.770	0.065	1.682	0.109					1.610		1.610	0.145			1.500	0.200	1.500	0.200								1.338	0.281
2	2.375	2.245	0.065	2.157	0.109					2.067		2.067	0.154			1.939	0.218	1.939	0.218								1.687	0.344
2.5	2.875	2.709	0.083	2.635	0.120					2.469		2.469	0.203			2.323	0.276	2.323	0.276								2.125	0.375
3	3.500	3.334	0.083	3.260	0.120					3.068		3.068	0.216			2.900	0.300	2.900	0.300								2.624	0.438
3.5	4.000	3.834	0.083	3.760	0.120					3.548		3.548	0.226			3.364	0.318	3.364	0.318									
4	4.500	4.334	0.083	4.260	0.120					4.026	0.237	4.026	0.237			3.826	0.337	3.826	0.337				3.624	0.438	3.624	0.438	3.438	0.531
5	5.563	5.345	0.109	5.295	0.134					5.047	0.258	5.047	0.258			4.813	0.375	4.813	0.375				4.563	0.500	4.563	0.500	4.313	0.625
6	6.625	6.407	0.109	6.357	0.134					6.065	0.280	6.065	0.280			5.761	0.432	5.761	0.432				5.501	0.562	5.501	0.562	5.187	0.719
8	8.625	8.407	0.109	8.329	0.148	8.125	0.250	8.071	0.277	7.981	0.322	7.981	0.322	7.813	0.406	7.625	0.500	7.625	0.500	7.437	0.594	7.187	0.719	7.187	0.719	6.183	1.221	
10	10.750	10.482	0.134	10.42	0.165	10.25	0.250	10.13	0.310	10.02	0.365	10.020	0.365	9.750	0.500	9.750	0.500	9.562	0.594	9.312	0.719	9.062	0.844	9.062	0.844	8.500	1.125	
12	12.750	12.420	0.165	12.39	0.180	12.25	0.250	12.09	0.330	12.00	0.375	11.938	0.406	11.626	0.562	11.750	0.500	11.370	0.690	11.060	0.845	10.750	1.000	10.750	1.000	10.120	1.315	
14	14.000			13.50	0.250	13.37	0.315	13.25	0.375	13.25	0.375	13.124	0.438	12.814	0.593	13.000	0.500	12.500	0.750	12.310	0.845	11.810	1.095	11.810	1.095	11.180	1.410	
16	16.000			15.50	0.250	15.37	0.315	15.25	0.375	15.25	0.375	15.000	0.500	14.688	0.656	15.000	0.500	14.310	0.845	13.930	1.035	13.560	1.220	13.560	1.220	12.810	1.595	
18	18.000			17.50	0.250	17.37	0.315	17.12	0.440	17.25	0.375	16.876	0.562	16.564	0.718	17.000	0.500	16.120	0.940	15.680	1.160	15.250	1.375	15.250	1.375	14.430	1.785	
20	20.000			19.50	0.250	19.25	0.375	19.25	0.375	19.25	0.375	18.814	0.593	18.376	0.812	19.000	0.500	17.930	1.035	17.430	1.285	17.000	1.500	17.000	1.500	16.060	1.970	
24	24.000			23.50	0.250	23.25	0.375	23.25	0.375	23.25	0.375	22.626	0.687	22.126	0.937	23.000	0.500	21.560	1.220	20.930	1.535	20.930	1.535	20.930	1.535	19.310	2.345	
30	30.000			29.37	0.315	29.00	0.500	29.00	0.500	29.25	0.375	29.250	0.375			29.000	0.500											
36	36.000			35.37	0.315	35.00	0.500	35.00	0.500	35.25	0.375	35.250	0.375			35.000	0.500											
42	42.000									41.25	0.375	41.250	0.375			41.000	0.500											
48	48.000									47.25	0.375	47.250	0.375			47.000	0.500											



FPS TO GPM CROSS - REFERENCE (Schedule 40)

Nominal Pipe (Inches)	I.D. INCH	1	1.5	2	2.5	3	3.5	4	4.5	5	5.5	6	6.5	7	7.5	8	8.5	9
1	1.05	2.6989	4.0484	5.3978	6.7473	8.097	9.4462	10.796	12.145	13.490	14.844	16.190	17.540	18.890	20.240	21.590	22.941	24.290
1.25	1.38	4.6620	6.9929	9.3239	11.655	13.99	16.317	18.648	20.979	23.310	25.641	27.970	30.300	32.630	34.960	37.300	39.627	41.958
1.5	1.61	6.3454	9.5182	12.691	15.864	19.04	22.209	25.382	28.555	31.730	34.900	38.070	41.250	44.420	47.590	50.760	53.936	57.109
2	2.07	10.489	15.734	20.979	26.224	31.47	36.713	41.958	47.202	52.450	57.692	62.940	68.180	73.430	78.670	83.920	89.160	94.405
2.5	2.47	14.935	22.402	29.870	37.337	44.80	52.272	59.740	67.207	74.670	82.142	89.610	97.080	104.50	112.00	119.50	126.95	134.41
3	3.07	23.072	34.608	46.144	57.680	69.22	80.752	92.288	103.82	115.40	126.90	138.40	150.00	161.50	173.00	184.60	196.11	207.65
3.5	3.55	30.851	46.276	61.702	77.127	92.55	107.98	123.40	138.83	154.30	169.68	185.10	200.50	216.00	231.40	246.80	262.23	277.66
4	4.03	39.758	59.636	79.515	99.394	119.3	139.15	159.03	178.91	198.80	218.67	238.50	258.40	278.30	298.20	318.10	337.94	357.82
5	5.05	62.430	93.645	124.86	156.07	187.3	218.50	249.72	280.93	312.10	343.36	374.60	405.80	437.00	468.20	499.40	530.65	561.87
6	6.06	89.899	134.85	179.80	224.75	269.7	314.65	359.60	404.55	449.50	494.45	539.40	584.30	629.30	674.20	719.20	764.14	809.09
8	7.98	155.89	233.83	311.78	389.72	467.7	545.61	623.56	701.50	779.40	857.39	935.30	1013.0	1091.0	1169.0	1247.0	1325.1	1403.0
10	10.02	245.78	368.67	491.56	614.45	737.3	860.23	983.12	1106.0	1229.0	1351.8	1475.0	1598.0	1720.0	1843.0	1966.0	2089.1	2212.0
12	11.94	348.99	523.49	697.99	872.49	1047.0	1221.5	1396.0	1570.5	1745.0	1919.5	2094.0	2268.0	2443.0	2617.0	2792.0	2966.5	3141.0
14	13.13	422.03	633.04	844.05	1055.1	1266.0	1477.1	1688.1	1899.1	2110.0	2321.1	2532.0	2743.0	2954.0	3165.0	3376.0	3587.2	3798.2
16	15.00	550.80	826.20	1101.6	1377.0	1652.0	1927.8	2203.2	2478.6	2754.0	3029.4	3305.0	3580.0	3856.0	4131.0	4406.0	4681.8	4957.2

FPS TO GPM: $GPM = (PIPE\ ID)^2 \times VELOCITY\ IN\ FPS \times 2.45$

GPM TO FPS: $FPS = \frac{GPM}{(ID)^2 \times 2.45}$

FPS X .3048 = MPS

GPM X .0007 = GPD

GPM X 3.7878 = LPM



FPS TO GPM CROSS - REFERENCE (Schedule 40)

Nominal Pipe (Inches)	I.D. INCH	1	1.5	2	2.5	3	3.5	4	4.5	5	5.5	6	6.5	7	7.5	8	8.5	9
18	16.88	697.52	1046.3	1395.0	1743.8	2093.0	2441.3	2790.1	3138.8	3488.0	3836.3	4185.0	4534.0	4883.0	5231.0	5580.0	5928.9	6277.7
20	18.81	866.14	1299.0	1732.0	2165.3	2598.4	3031.5	3464.6	3897.6	4330.7	4763.8	5196.8	5629.9	6063.0	6496.0	6929.1	7362.2	7795.3
24	22.63	1253.7	1880.0	2507.0	3134.1	3761.0	4387.8	5014.6	5641.5	6268.3	6895.1	7522.0	8148.8	8775.6	9402.4	10029	10656	11283
26	25.25	1560.7	2341.0	3121.0	3901.9	4682.2	5462.6	6243.0	7023.4	7803.7	8584.1	9364.5	10145	10925	11706	12486	13266	14047
28	27.25	1817.8	2727.0	3636.0	4544.5	5453.4	6362.3	7271.2	8180.0	9088.9	9997.8	10907	11816	12725	13633	14542	15451	16360
30	29.25	2094.4	3142.0	4189.0	5236.0	6283.2	7330.4	8377.6	9424.9	10472	11519	12566	13614	14661	15708	16755	17803	18850
32	31.25	2390.6	3586.0	4781.0	5976.5	7171.9	8367.2	9562.5	10758	11953	13148	14344	15539	16734	17930	19125	20320	21516
34	33.25	2706.4	4060.0	5413.0	6766.0	8119.2	9472.4	10826	12179	13532	14885	16238	17592	18945	20298	21651	23004	24358
36	35.25	3041.8	4563.0	6084.0	7604.5	9125.4	10646	12167	13688	15209	16730	18251	19772	21292	22813	24334	25855	27376
42	41.25	4165.4	6248.0	8331.0	10414	12496	14579	16662	18744	20827	22910	24992	27075	29158	31241	33323	35406	37489
48	47.99	5637.8	8457.0	11276	14095	16913	19732	22551	25370	28189	31008	33827	36646	39465	42284	45103	47922	50740
54	53.98	7133.1	10700	14266	17833	21399	24966	28532	32099	35665	39232	42798	46365	49931	53498	57065	60631	64198
60	60.09	8839.2	13259	17678	22098	26518	30937	35357	39777	44196	48616	53035	57455	61875	66294	70714	75134	79553
72	72.10	12726	19089	25451	31814	38177	44540	50903	57266	63628	69991	76354	82717	89080	95443	101805	108168	114531
84	84.10	17314	25971	34628	43285	51943	60600	69257	77914	86571	95228	103885	112542	121199	129856	138514	147171	155828

FPS TO GPM: $GPM = (PIPE\ ID)^2 \times VELOCITY\ IN\ FPS \times 2.45$

GPM TO FPS: $FPS = \frac{GPM}{(ID)^2 \times 2.45}$

FPS X .3048 = MPS

GPM X .0007 = GPD

GPM X 3.7878 = LPM

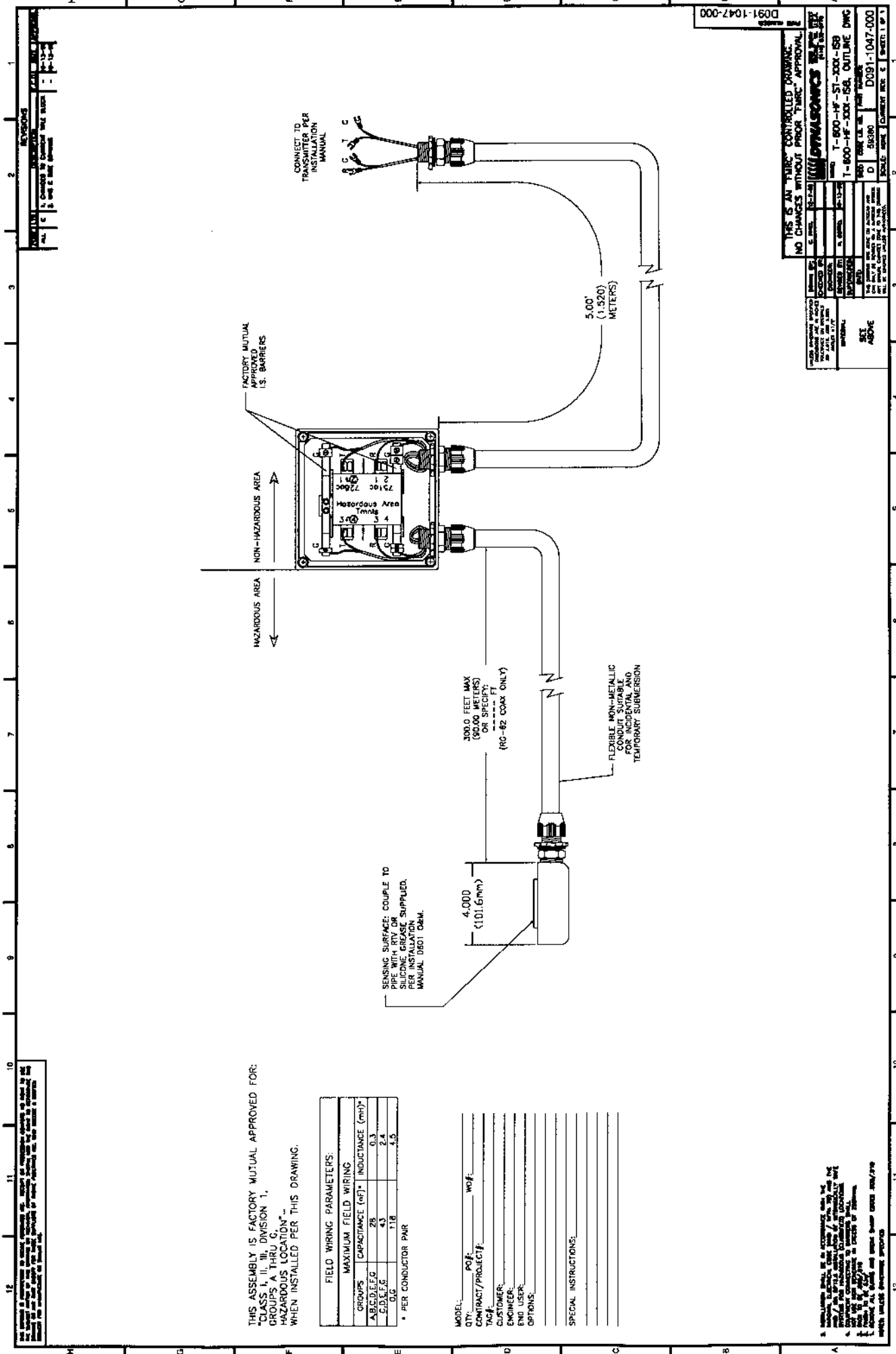

THIS ASSEMBLY IS FACTORY MUTUAL APPROVED FOR:
 CLASS I, II, III, DIVISION 1,
 GROUPS A THRU G,
 HAZARDOUS LOCATION**
 WHEN INSTALLED PER THIS DRAWING.

FIELD WIRING PARAMETERS:

GROUPS	CAPACITANCE (pf)*	INDUCTANCE (mh)*
A,B,C,D,E,F,G	28	0.3
H,I,J,K,L,M	43	2.4
N,O,P	118	4.5

* PER CONDUCTOR PAIR

MODEL: _____ QTY: _____ WOF: _____
 CONTRACT/PROJECT: _____
 TAG: _____
 CUSTOMER: _____
 ENGINEER: _____
 END USER: _____
 OPTIONS: _____
 SPECIAL INSTRUCTIONS: _____

1. INSTALLATION SHALL BE ACCORDING WITH THE
 MANUFACTURER'S INSTRUCTIONS AND THE
 NATIONAL ELECTRICAL CODE (NEC) AND THE
 LOCAL ELECTRICAL CODES. THE USER SHALL
 BE RESPONSIBLE FOR OBTAINING ALL NECESSARY
 PERMITS AND APPROVALS FROM THE LOCAL
 ELECTRICAL INSPECTOR AND THE LOCAL
 FIRE DEPARTMENT. THE USER SHALL
 BE RESPONSIBLE FOR OBTAINING ALL
 NECESSARY APPROVALS FROM THE
 LOCAL ELECTRICAL INSPECTOR AND THE
 LOCAL FIRE DEPARTMENT.

THIS IS AN "IN-PROCESS" DRAWING. NO CHANGES WITHOUT PRIOR "IN-PROCESS" APPROVAL.

RAYSONICS

1-800-HF-ST-300-69
 1-800-HF-300-68, OUTLINE DWG
 50380
 D091-1047-000

THIS DRAWING IS THE PROPERTY OF RAYSONICS. IT IS TO BE USED ONLY FOR THE PROJECT AND LOCATION SPECIFICALLY IDENTIFIED HEREON. IT IS NOT TO BE REPRODUCED, COPIED, OR TRANSMITTED IN ANY FORM OR BY ANY MEANS, ELECTRONIC OR MECHANICAL, INCLUDING PHOTOCOPYING, RECORDING, OR BY ANY INFORMATION STORAGE AND RETRIEVAL SYSTEM. WITHOUT THE WRITTEN PERMISSION OF RAYSONICS.

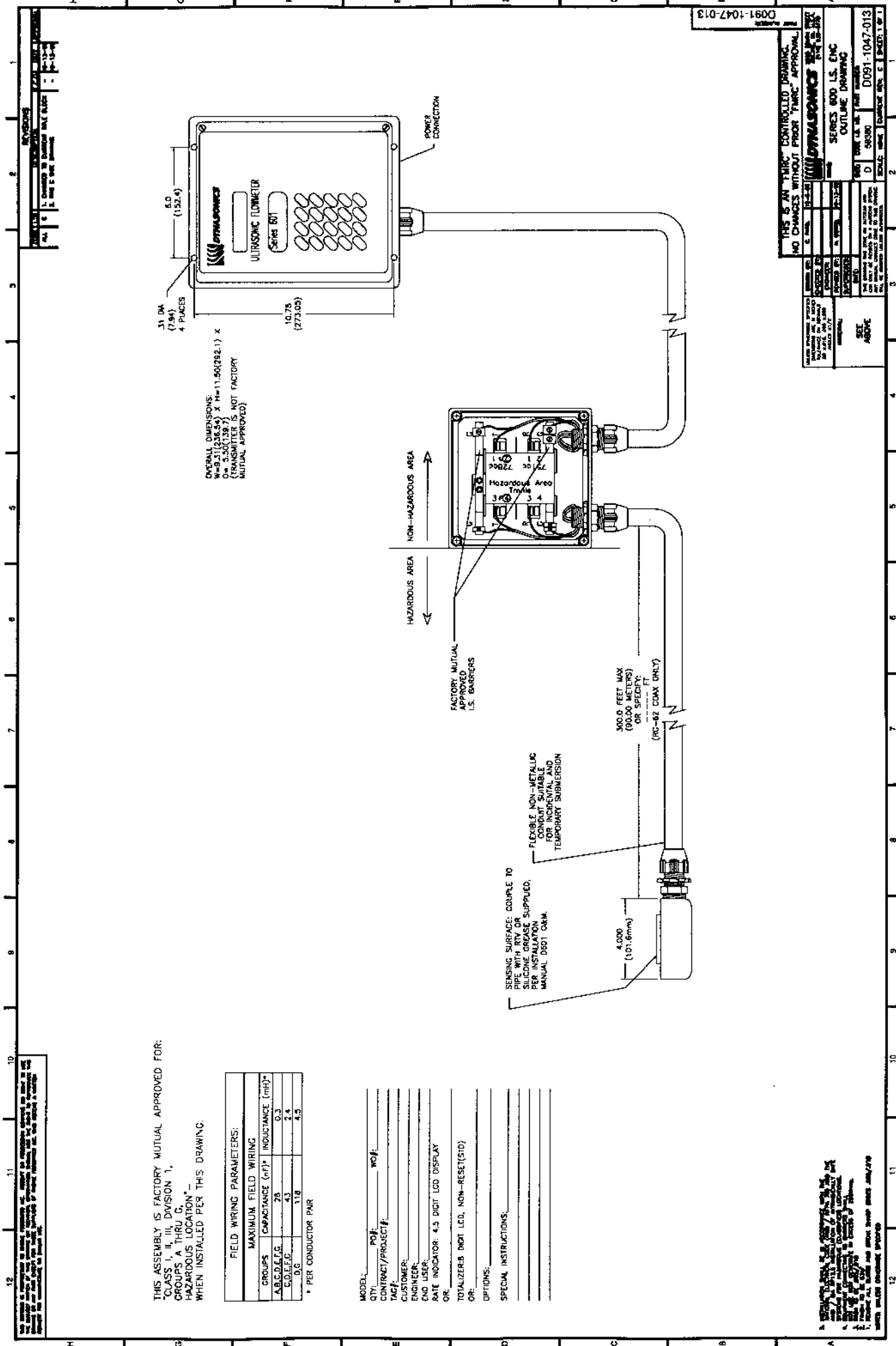

THIS ASSEMBLY IS FACTORY MUTUAL APPROVED FOR:
 CLASS I, II, III, DIVISION 1,
 GROUPS A, THRU G,
 HAZARDOUS LOCATION -
 WHEN INSTALLED PER THIS DRAWING.

FIELD WIRING PARAMETERS:			
MAXIMUM FIELD WIRING			
GROUPS	CAPACITANCE (pF)	INDUCTANCE (mH)*	
A,B,C,D,E,F,G	25	0.3	
G,D,E,F,G	43	2.4	
D,G	118	4.5	

* PER CONDUCTOR PAIR

MODEL: _____
 QTY: _____ PO#: _____ WOF: _____
 CONTRACT/PROJECT#: _____
 TAC#: _____
 CUSTOMER: _____
 ENGINEER: _____
 END USER: _____
 RATE INDICATOR: 4.5 DIGIT LCD DISPLAY
 OR:
 TOTALIZER'S DIGIT LED, NON-RESET(S10)
 OR:
 OPTIONS: _____
 SPECIAL INSTRUCTIONS: _____

REV. NO.	DATE	BY	DESCRIPTION
1	01-11-80	J. J.
2	01-11-80	J. J.

THIS IS AN 'FMIC' CONTROLLED DRAWING.
 NO CHANGES WITHOUT PRIOR 'FMIC' APPROVAL.

FMIC
 SERIES 800 L.S. ENC
 OUTLINE DRAWING

DATE: 01-11-80
 D: 58300
 D091-1047-013

1. THIS DRAWING IS THE PROPERTY OF FMIC. IT IS TO BE USED ONLY FOR THE PROJECT AND LOCATION SPECIFIED HEREON. IT IS NOT TO BE REPRODUCED, COPIED, OR TRANSMITTED IN ANY FORM OR BY ANY MEANS, ELECTRONIC OR MECHANICAL, INCLUDING PHOTOCOPYING, RECORDING, OR BY ANY INFORMATION STORAGE AND RETRIEVAL SYSTEM, WITHOUT THE WRITTEN PERMISSION OF FMIC.



GENERAL TERMS AND CONDITIONS OF SALES

1. **PAYMENT** – Terms of payment are effective from the actual date of invoice. If, in the Seller's opinion, the financial condition of the Buyer at any time – or any other circumstances – do not justify the incurrence of production costs of shipment on the terms of payment specified, the Seller may require partial or full payment in advance. Payment terms are net 30 days unless otherwise stated on invoice.
2. **F.O.B.** – All shipments are from Racine, Wisconsin, USA, unless otherwise other stated, and title transfers to the buyer upon leaving factory.
3. **QUOTATION AND PRICES** – Quoted prices are firm for 30 days unless stated in the quotation and are subject to change without notice after expiration of this period.
4. **TAXES** – Any applicable sales, use, revenue, excise or other taxes not specifically stated in the quotation are to be remitted by the Buyer directly to the appropriate regulatory agency.
5. **WARRANTY** – Seller's standard published warranty in effect at the time of shipment shall apply. This warranty is exclusive and is in lieu of all other warranties, express, implied, or statutory, including the warranty of merchantability.
6. **DELIVERY** – The Seller shall not be liable for loss or damage of any kind resulting from delay or inability to deliver on account of flood, fire, labor trouble, riots, civil disturbances, accidents, acts or orders or regulations of civil or military authorities, shortages of material, or any other causes beyond Seller's control.
7. **PRODUCT CHANGES** – In keeping with our continuing policy of product improvement, we reserve the right to make changes in our products at any time, without incurring an obligation to change, replace or upgrade equipment previously shipped.
8. **CANCELLATIONS** – An order placed by Buyer and accepted by Seller may be cancelled only with the Seller's consent and upon terms that will indemnify the Seller against loss.
9. **RESTOCKING CHARGE** – On standard equipment, the charge is 25%, provided the equipment is returned within 30 days in acceptable condition with a RGA number. Restocking charges for special equipment may vary from standard equipment, and will be handled on a case-by-case basis. No returns will be taken after one year.



Limited Warranty and Disclaimer

Dynasonics, div. of Racine Federated Inc. warrants to the end purchaser, for a period of one year from the date of shipment from our factory, that all new transmitters and transducers manufactured by it are free from defects in materials and workmanship. This warranty does not cover products that have been damaged due to normal use, misapplication, abuse, lack of maintenance, or improper installation. Dynasonics' obligation under this warranty is limited to the repair or replacement of a defective product, at no charge to the end purchaser, if the product is inspected by Dynasonics and found to be defective. Repair or replacement is at Dynasonics' discretion. An authorization number must be obtained from Dynasonics before any product may be returned for warranty repair or replacement. The product must be thoroughly cleaned and any process chemicals removed before it will be accepted for return.

The purchaser must determine the applicability of the product for its desired use and assumes all risks in connection therewith. Dynasonics assumes no responsibility or liability for any omissions or errors in connection with the use of its products. Dynasonics will under no circumstances be liable for any incidental, consequential, contingent or special damages or loss to any person or property arising out of the failure of any product, component or accessory.

All expressed or implied warranties, including **the implied warranty of merchantability and the implied warranty of fitness for a particular purpose or application are expressly disclaimed** and shall not apply to any products sold or services rendered by Dynasonics.

The above warranty supersedes and is in lieu of all other warranties, either expressed or implied and all other obligations or liabilities. No agent or representative has any authority to alter the terms of this warranty in any way.

RETURN OF EQUIPMENT/SALES INFORMATION

CONTACTS AND PROCEDURES

Customer Service/Application Engineer:

If you have a question regarding order status, placing an order, reviewing applications for future purchases, or wish to purchase a new flowmeter, please contact our new National Sales and Marketing Headquarters:

DYNASONICS
Division of Racine Federated, Inc.
8635 Washington Avenue
Racine, WI 53406
PHONE: (800)535-3569 or
(262)639-6770
FAX: (262)639-2267

Service/Repair Department:

If you already purchased equipment and have an operation problem, require service, or need to schedule field service, please contact our Service Department:

DYNASONICS
Division of Racine Federated, Inc.
8635 Washington Avenue
Racine, WI 53406
PHONE: (800)535-3569 or
(262)639-6770
FAX: (262)639-2267

Return Goods Authorization:

When returning equipment, it is necessary for you to contact our Service Department at (800)535-3569 or (262)639-6770 to obtain an RGA number for the authority and proper tracking of your material and its prompt inspection and return. The RGA number should be noted on the outside of the box. All returns of equipment go to the following address:

DYNASONICS
Division of Racine Federated, Inc.
8635 Washington Avenue
Racine, WI 53406
Attn: RGA #



8635 WASHINGTON AVENUE
RACINE, WI 53406

TOLL-FREE IN NORTH AMERICA.:

TEL: (800) 535-3569 FAX: (800) 732-8354

TEL: (262) 639-6770 FAX: (262) 639-2267

URL: www.dynasonics.com